



AI-516 / AI-516P ARTIFICIAL INTELLIGENCE INDUSTRIAL CONTROLLER

(Applicable for accurate controls of Temperature, Pressure, Flow, Level and Humidity etc.)

Operation Instruction

(ver.9.1)





www.yudian.com

Yudian Copyright (1991-2022)

S094-08

CONTENTS

1. SUMMARY	1
1.1 Main Features	1
1.2 Ordering Code Definition	2
1.3 Modules	6
1.3.1 Slots of modules	6
1.3.2 Commonly used modules	7
1.3.3 Installation and replacement of modules	8
1.3.4 Electric isolation of the modules	8
1.3.5 Further descriptions about module applications	9
1.4 Technical Specification	10
1.5 Wiring Diagram	13

2. DISPLAYS AND OPERATIONS	22
2.1 Front Panel Description.....	22
2.2 D71/E71 Rail Mount Panel Description.....	24
2.3 Display Status.....	25
2.4 Operation Description.....	26
2.4.1 Parameter Setting.....	26
2.4.2 Short-cut operation.....	26
3. PARAMETERS AND SETTINGS	29
3.1 Parameter Lock (Loc) And Field Parameters.....	29
3.2 The Parameter Table.....	29
3.3 Additional Explanation On Special Functions.....	42
3.3.1 Single-phase phase-shift trigger output.....	42
3.3.2 Alarm blocking at the beginning of power on.....	42

3.3.3 Communication function	43
3.3.4 Temperature re-transmitter / Program generator	43
4. PROGRAM CONTROL (AI-516P ONLY).....	45
4.1 Functions And Concepts	45
4.2 Program Arrangement	48
4.2.1 Ramp Mode	48
4.2.2 Soak Mode	51
4.2.3 Time Setting	51
4.2.4 Set Point Setting	52
4.2.5 Program arrangement of multi-curve operation	52

1. SUMMARY

1.1 Main Features

- Accurate digital calibration technology for input measurement. Wide range of thermocouples and RTD are supported. Maximum resolution is 0.01°C.
- Advanced artificial intelligent control algorithm to avoid overshoot. Auto tuning (AT) is provided.
- Innovative modular structure enables abundant output options to adapt different applications. Quick production lead time and convenience in maintenance are benefited.
- User-friendly operation user interface.
- Customization on operation authorization and interface, as if it is tailor-made.
- Universal power supply 100-240VAC or 24VDC is possible. Different installation dimensions are available.
- Anti-interference ability complies with requirement of electromagnetic compatibility under adverse industrial environment

POINTS FOR ATTENTION

- This manual is for ARTIFICIAL INTELLIGENCE TEMPERATURE CONTROLLER AI-516/AI-516P Version 9.0. Some functions described in this manual may not applicable in other versions. The display will show instrument model and firmware version upon power on. User should pay attention to the difference between different versions. Please read this manual carefully in order to use the instrument correctly and make it to its full use.

- Please correctly set parameters according to input / output type and function. Only correctly wired instruments with parameters correctly set can be put into use.

1.2 Ordering Code Definition

Advanced modularized hardware design is utilized for AI series instruments. There are maximum 5 module slots: multi-function input/output (MIO), main output (OUTP), alarm (ALM), auxiliary output (AUX) and communication (COMM). The modules can be purchased together or individual, and can be assembled freely. The input type can be set to thermocouple, RTD, or linear current/voltage.

The ordering code of AI-516/AI-516P series instrument is made up of 9 parts. For example:

<u>AI-516</u>	<u>A</u>	<u>N</u>	<u>X3</u>	<u>L3</u>	<u>N</u>	<u>S4</u>	-	<u>24VDC - (F2)</u>
①	②	③	④	⑤	⑥	⑦		⑧ ⑨

It shows that the model of this instrument is ①AI-516, ②front panel dimension is A size(96×96mm), ③no module is installed in MIO slot, ④X3 linear current output module is installed in OUTP (main output), ⑤ALM (alarm) is L3 (dual relay contact output module), ⑥no module is installed in AUX (auxiliary output), ⑦S4 (RS485 communication interface module) is installed at COMM, ⑧and the power supply of the instrument is 24VDC, ⑨an extended input type (F2 radiation type pyrometer) is available

The following is the meanings of the 9 parts:

① Instrument Model

AI-516 Economical temperature controller with measurement accuracy 0.25%F.S, with artificial intelligent controlling technology, various types of alarm, retransmission and communication.

AI-516P On top of AI-516, providing 30 segments of time-procedure programmable function.

② Panel Dimension

	Panel Code	Dimension Width x Height (mm)	Depth behind mount (mm)	Opening Dimension Width x Height (mm)	Light Bar
Standard Depth	A	96 x 96	100	$92^{+0.5} \times 92^{+0.50}$	---
	A2				25 segments in 4 levels of luminosity at 1% resolution
	B	160 x 80	100	$152^{+0.5} \times 76^{+0.5}$	---
	B2				25 segments in 4 levels of luminosity at 1% resolution
	C	80 x 160	100	$76^{+0.5} \times 152^{+0.5}$	---
	C3				50 segments in 2 levels of luminosity at 1% resolution
	E	48 x 96	100	$45^{+0.5} \times 92^{+0.5}$	---
	E2				25 segments in 4 levels of luminosity at 1% resolution
	F	96 x 48	100	$92^{+0.5} \times 45^{+0.5}$	---
	D	72 x 72	95	$68^{+0.5} \times 68^{+0.5}$	---
	D2	48 x 48	95	$45^{+0.5} \times 45^{+0.5}$	---
	D6	48 x 48	95	$46^{+0.5} \times 46^{+0.5}$	---
Short Depth	A1	96 x 96	70	$92^{+0.5} \times 92^{+0.50}$	---
	A21				25 segments in 4 levels of luminosity at 1% resolution
	B1	160 x 80	70	$152^{+0.5} \times 76^{+0.5}$	---

	B21				25 segments in 4 levels of luminosity at 1% resolution
	C1	80 x 160	70	$76^{+0.5} \times 152^{+0.5}$	---
	C31				50 segments in 2 levels of luminosity at 1% resolution
	D1	48x48	80	$45^{+0.5} \times 45^{+0.5}$	---
	E1	48 x 96	70	$45^{+0.5} \times 92^{+0.5}$	---
	E21				25 segments in 4 levels of luminosity at 1% resolution
	F1	96 x 48	70	$92^{+0.5} \times 45^{+0.5}$	---
Dail Mount	D5	22.5 x 100	112	DIN rail mount. Optional external E8 keypad is required to be plugged for parameter setting and operation.	
	D71	22.5 x 100	112	Power and communication wiring method are grouped in hot-plugged terminals. Others specification are the same as E7.	
	E71	22.5 x 100	112	DIN rail mount. Specially designed compact dual LED display with operation buttons.	
	E5	48 x 96	100	DIN rail mount. Optional external E8 keypad is required to be plugged for parameter setting and operation.	
	E51	48 x 96	70	DIN rail mount. Optional external E8 keypad is required to be plugged for parameter setting and operation.	

- ③ **Module available in multiple functions I/O (MIO):** I2, I4, K3, V, etc. N denotes that there is no module installed. Same as below.
- ④ **Module available in main output (OUTP):** L1, L2, L4, W1, W2, G, K1, K3, X3, X5, etc.
- ⑤ **Module available in alarm (ALM):** L0, L2, L3, L4, W1, W2, G, etc.
- ⑥ **Module available for auxiliary output (AUX):** L0, L1, L2, L3, L4, W1, W2, G, K1, X3, X5, etc.
- ⑦ **Module available for communication (COMM):** S, S4, V, etc.
- ⑧ **Power supply of the instrument:** If it is left blank, the power of the instrument is 100~240VAC. "24VDC" means the power supply of 20~32V DC or AC power (required to be specified upon ordering).
- ⑨ **Extended graduation specification:** (If there is none, leave it blank). AI-516/516P series instruments input is already universal supporting common thermocouples, RTDs, linear voltage, current and resistance inputs (Please refer to the latter part of technical specification). If it is required, an additional specification can be extended.

Note 1: The instrument applies the technology of automatic zero and digital calibration, and is free of maintenance. If the error exceeds certain range, cleaning and drying of the inside parts will improve. If it is not, please send the instrument back to the factory to examine and repair.

Note 2: Please specify the error phenomenon and reason to ensure proper and complete repair if it is sent back for repair.

1.3 Modules

1.3.1 Slots of modules

There are 5 module slots in AI-516/516P series instruments. (3 slots, OUTP, AUX and COMM/AL1 for D dimension. 2 slots, OUTP and COMM/AUX for D6 dimension). Different modules installed will provide different functions and output types.

- **Multiple function Input / Output (MIO):**

By installing I4 module with 24VDC loop power, the instrument reads input signal from 2-wire transmitter or 4-20mA signal. Installing K3 module will provide three-phase thyristor zero-crossing triggering output.

- **Main output (OUTP):**

As control output such as on-off control, standard PID control, and AI PID control. It can also be used as retransmission output of process value (PV) or set point (SV). Installing L1 or L4 modular will provide relay contact output. Installing X3 or X5 module will provide 0-20mA/4-20mA/0-10mA linear current output. Installing G module will provide SSR voltage output. Installing W1 or W2 module will provide TRIAC no contact switch output.

- **Alarm (ALM):** Installing L0 or L2 will provide 1 normally open + normally close relay output (AL1). Installing L3 module will provide 2 normally open relay outputs (AL1+AL2).

- **Auxiliary output (AUX):** Installing L0, L1, L2 or L3 relay module can work as alarm. Installing R module (RS232C interface) will provide communication feature with computer.

- **Communication Interface (COMM):** Installing module S or S4 (RS485 communication interface) provides

communication feature with computer. Installing voltage output module will provide power supply for external sensor or transmitter.

1.3.2 Commonly used modules

- N** (Or left blank) No module installed
- L0** Large capacity and large size relay. Normally open(NO) + normally close(NC) relay output module. (Capacity: 30VDC/2A, 250VAC/2A, suitable for alarm)
- L1** Large capacity and large size relay. NO relay output module. (Capacity: 30VDC/2A, 250VAC/2A)
- L2** Small capacity and small size relay. NO+NC relay output module. (Capacity: 30VDC/1A, 250VAC/1A, suitable for alarm)
- L3** Dual channel, large capacity and large size relay. NO relay output module. (Capacity: 30VDC/2A, 250VAC/2A)

- L4** Large capacity but small size relay. NO+NC relay output module. (Capacity: 30VDC/2A, 250VAC/2A)
- W1/W2** TRIAC no contact NO (W2 is NC) discrete output module (Capacity: 100~240VAC/0.2A, burn-proof)
- G** Solid-state relay (SSR) voltage output module (12VDC/30mA)
- G5** Dual SSR voltage output module
- K1/K3** Single channel/3-channel thyristor zero-crossing trigger output module (Each channel triggers one loop of a TRIAC or a pair of inverse parallel SCR with current of 5~500A)
- K50/K60** Single channel 220VAC/380VAC thyristor phase-shift trigger output module (Each channel triggers one loop of TRIAC or a pair of inverse parallel SCR with current of 5~500A). Only 50Hz power is allowed.
- X3** Photoelectric programmable linear current output module
- X5** Photoelectric programmable linear current output module with own photoelectric isolated power supply.
- S** Photoelectric RS485 communication interface module.

- S1** Photoelectric RS485 communication interface module. (Uses internal 24V isolated power)
- S4** Photoelectric RS485 communication interface module with own photoelectric isolated power supply.
- S6** RS485 MODBUS-RTU Communication Interface Module (Photoelectric Isolation, internal 12V)
- R** Photoelectric RS232C communication interface module.

V24/V12/V10

Isolated 24V/12V/10V DC voltage output with maximum current of 50mA for power supply of external transmitter or circuit.

I2 Switch / frequency signal input interface for external switch or frequency signal, with 12VDC power supply for external sensor.

I4 4-20mA/0-20mA analogue input interface with 24VDC/25mA power supply for 2-wire transmitter.

SL Designed for D6 dimension. Photoelectric RS485 communication interface module with a single channel NO relay output module. (Uses internal 12V isolated power)

1.3.3 Installation and replacement of modules

Module installation and corresponding parameter setting is done by factory. If there is faulty modules to be replaced or functions to be changed, users can replace by themselves. Users can pull the controller board out of the housing, using a small flat-tip screwdriver to insert into the opening between the original module and the slot, removing the existing module and replacing a new one. Changing a module type often require users to modify the corresponding parameters.

1.3.4 Electric isolation of the modules

There are a group of 24V and a group 12V power supply built in the instrument and isolated to the main circuit. The 24V power commonly supplies voltage output module, such as V24/V12/V10 (24V/12V/10V voltage output), I2 (frequency/on-off input, with 12V isolated voltage output) and I4, etc. The 12V power commonly supplies power for

output or communication module. Generally, the relay contact output and TRIAC no contact discrete output are self-isolated from the other circuit or does not require isolated power. Therefore, only the electric isolation between the communication interface and the current output should be considered. S (RS485 communication interface), R (RS232 communication interface) and X3 (linear current output) all draws from the internal 12V power supply. If more than one of the above modules are installed, they will be not electrically isolated because they share the same power supply. To avoid interference, S4 (RS485 communication interface) or X5 (linear current output) is designed. They have their own isolated power supply, without drawing from instrument internal power. For example, if an X3 module is installed in main output (OUTP) slot, S4 or X5 should be installed in communication (COMM) slot. For relay contact point and thyristor no contact point output, they are isolated from other circuits already. Isolation for SSR voltage output (G) generally is not required because solid –state relay itself is isolated.

1.3.5 Further descriptions about module applications

- **Voltage output module:** The voltage output modules like V24, V12, V10 are often used for supplying power for external transducer or feedback resistance of transmitter. These modules can be installed in any slot. To standardize the wiring, it is recommended to be installed in the first idle slot in the order of MIO, AUX, and COMM.
- **No contact switch module:** W1/W2 are newly developed non-contact switch module with advanced “burn proof” technology and zero-crossing conduction. It can replace the relay contact switch to control AC contactor actuator or electric servo motor. Compared to the relay contact output module, W1/W2 have longer life span and able to lower the interference spark. This improves the stability and reliability of the system. Since the driving component

is thyristor, it is suitable to control 100~240VAC but no DC. Since output terminals are connected in series with protection components, the allowed continuous current for control is up to 0.2A with allowed maximum instantaneous current up to 2A. This driving power can directly control AC contactor of 220VAC with current below 80A. For the load larger than 80A, an intermediate relay is needed.

- **Relay switch module:** The relay modules are widely used in industrial control. However, they are the only modules with life time limit and size limit and also bringing large amount of electromagnetic interference. It is important to choose a suitable relay module. To control equipment with 100~220VAC supply, such as AC contactor and electromagnetic valve, W1 module is recommended. To control DC or AC above 50VAC, relay module L1, L4, etc can only be chosen. L2 module is small without size limitation and both of its normal open and normal close terminals have varistor spark absorption. But the capacity is small therefore It is suitable for alarm output. L1 and L3 are larger in size and higher in capacity and cannot be installed in compact instrument such as D2 and D6 panel ones. Otherwise the modules will collide to one another. If either main or side board is L1 or L3 installed, another board cannot have L1 or L3 installed at the same time. L3 module provides dual relay outputs. It can be used to support two loops of alarm, for example, AL1+AL2. If mechanical switch is not preferred, G5 (dual SSR voltage driver) with external solid-state relay (SSR) can be used to drive the load instead.

1.4 Technical Specification

- **Input Specification: (One instrument is compatible to the following)**
Thermocouple: K, S, R, E, J, T, B, N, WRe3-WRe25, WRe5-WRe26, etc
Resistance temperature detector: Cu50, Pt100

Linear voltage: 0~5V, 1~5V, 0~100mV, 0~20mV, 0~500mV etc.

Linear current (with I4 module installed in MIO slot): 0~20mA, 4~20mA, two-wire transmitter, etc.

Extended specification: Apart from the above-mentioned Input specification, an additional type can be provided upon request. (Graduation index may be required to provide by customer)

- **Instrument Input range**
K(-50~1300℃), S(-50~1700℃), R(-50~1700℃), T(-200~+350℃), E(0~800℃), J(0~1000℃), B(200~1800℃), N(0~1300℃),
Cu50(-50~+150℃), Pt100(-200~+600℃)
Linear Input: -9990~30000 defined by user
- **Measurement accuracy** : 0.25%FS
- **Resolution** : 0.1℃ for K, E, T, N, J, Cu50, Pt100; 1℃ for S,R
- **Sampling period**: 8 times per second. By setting digital filter parameter FILt=0, the response time ≤0.5 second.
- **Control period** : 0.24~300.0 seconds selectable, and it should be integer times of 0.5 second.
- **Regulation mode**:
On-off control mode (dead band adjustable)
AI-PID with fuzzy logic PID regulating and auto tuning with advance artificial intelligence algorithm.
- **Output specification (Modularized)**
Relay output (NO+NC): 250VAC/1A or 30VDC/1A
TRIAC no contact discrete output (NO or NC): 100 ~ 240VAC/0.2A (continuous), 2A (20mS instantaneous, repeat period≥5s)

SSR Voltage output: 12VDC/30mA (To drive solid-state relay SSR).

Thyristor zero-crossing trigger output: To trigger TRIAC of 5~500A, a pair of inverse paralleled SCRs or SCR power module.

Linear current output: 0~10mA or 4~20mA customized. (X3 module installed, output voltage \geq 10.5V. X5 module installed, output voltage \geq 7V)

- **Alarm function:** 4 types of alarm, high limit, low limit, deviation high limit and deviation low limit with alarm blocking at the beginning of power on.
- **Electromagnetic compatibility (EMC):** \pm 4KV/5KHz according to IEC61000-4-4 (Electrical Fast Transient); 4KV according to IEC61000-4-5 (Electrical Surge).
- **Isolation withstanding voltage:** Among power, relay contact or signal terminals \geq 2300VDC. Among isolated electroweak terminals \geq 600V

- **Power supply:** 100~240VAC, -15%, +10% / 50~60Hz; 120~240VDC; or 24VDC/AC, -15%, +10%.
- **Power consumption:** \leq 5W
- **Operating ambient:** Temperature -10~60 $^{\circ}$ C. Humidity \leq 90%RH

1.5 Wiring Diagram

Wiring diagram of rear terminals of standard depth

Note :① For linear voltage input, if the range is below 500mV, connect to terminals 19 and 18. 0~5V or 1~5V signal can be inputted from terminals 17 and 18.

② 4~20mA linear current signal can change to 1~5V voltage signal by connecting a 250 ohm resistor, and then be inputted from terminals 17 and 18. If I4 module is installed in MIO slot, 4~20mA signal can be inputted from terminals 14+ and 15-, and 2-wire transmitter can be inputted from terminals 16+ and 14-.

③ The compensation wires for different kinds of thermocouple are different, and should be directly connect to the terminals. When the internal auto compensation mode is used, connecting the common wire between the compensation wire and the terminals will cause measurement error.

④ When main output is selected linear current or SSR voltage, the output will be given from terminal 13+, 11-.

⑤ OP1/AL1/AU1 are normal open and OP2/AL2/AU2 are normal close when single channel relay module such as L1 or L2 is installed.

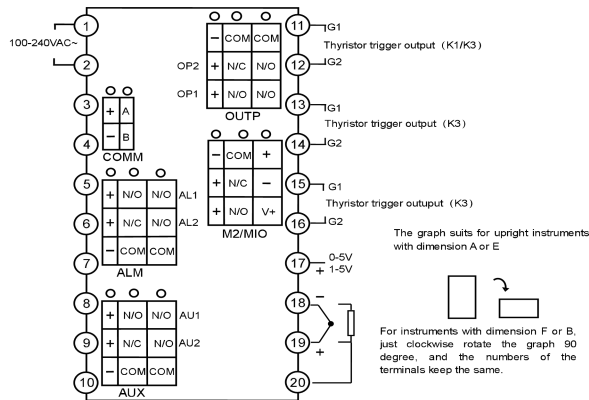

Wiring diagram of dimension D (72×72mm)

Note 1: Linear voltage signal of range below 500mV should be inputted from terminals 13 and 12, and signal of 0~5V and 1~5V should be inputted from terminals 11 and 12.

Note 2: 4~20mA linear current signal can be converted to 1~5V voltage signal by connecting a 250 ohm resistor and inputted from terminals 11 and 12.

Note 3: S or S4 module can be installed in COMM slot for communication. If relay, TRIAC no contact switch, or SSR drive voltage output module is installed in COMM, it can be used as AL1 alarm output.

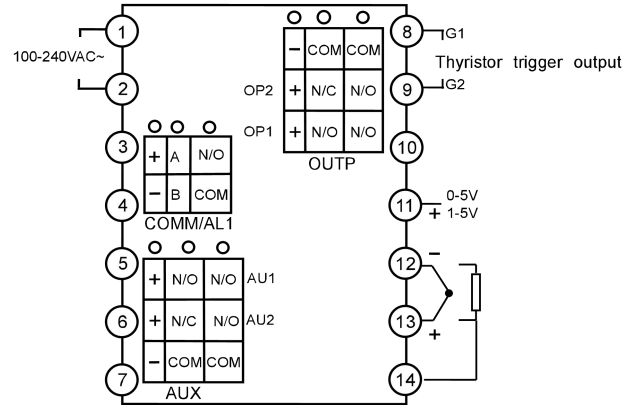

Wiring diagram of dimension D1/D2 (48x48mm)

Note 1: Dimension D1/D2 instruments do not support 0~5V nor 1~5V linear voltage input. Instead, 0~5V or 1~5V signal can be converted to 0~500mV or 100~500mV respectively by voltage divider while 4 ~ 20mA can be converted to 100~500mV by connecting a 25ohm resistor in parallel, then be inputted from terminals 9 and 8.

Note 2: In COMM/AUX slot of Dimension D2, S or S4 communication module provides RS485 communication. If L2 module is installed in, it acts as alarm at AU1. If L3 dual relay module is installed with parameter bAud = 0, it acts as AU1 and AU2 alarm output. If parameter bAud = 2, it acts as alarms at AU1 and AL1. L1, L2, L4, G, K1, W1 or W2 modules can be installed as the auxiliary output in bidirectional (heating/refrigerating) control. If I2 module is installed with bAud = 1, it simulates MIO slot to read on-off input (terminals 3 and 5) to switch between SP1/SP2 or switch the program status RUN / STOP of a programmable controller.

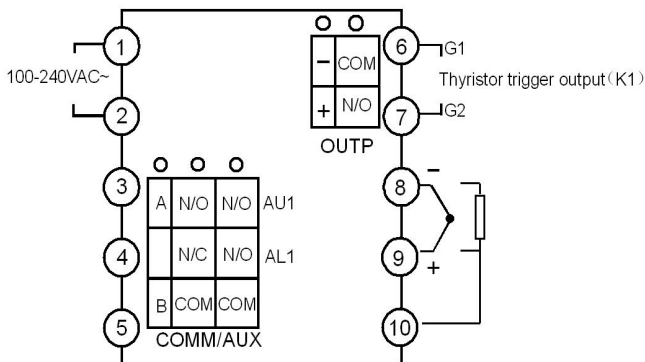

Wiring diagram of dimension D5

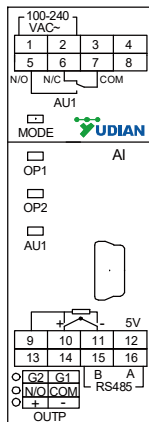

Note1: Dimension D5 instruments are fixed with one loop of alarm and communication feature. Available main output module are G, X5, L2, K1, K50, K60 and W1.

Note 2: 0~5V/1~5V is input from 12+, 11-. 500mV or below is input from 10+, 11-. 4~20mA with 250ohm shunt resistor converting to 1~5V is input from 12+, 11-.

Wiring diagram of dimension D6 (48×48mm)

Note 1: Linear voltage 0~5V or 1~5V input from 9+ and 10-;

500mV or below input from 11+ and 10-;

External precise resistor 250ohm can be paralleled shunt to convert 4~20mA to 1~5V then input from 9+ and 10-;

Note 2: In COMM/AUX slot, installing L3 dual relay module provides two alarms while installing SL module provides RS485 communication and one alarm.

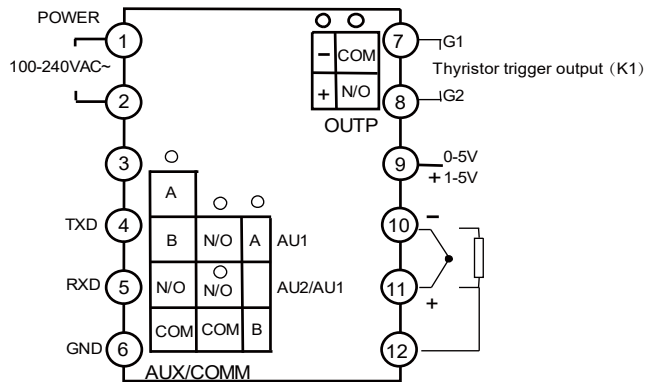

Wiring diagram of dimension D71 (22.5 x 100mm)

Note 1: Input

0~5V/1~5V input from 16+, 15-

500mV below input from 14+, 15-

4~20mA with 250ohm shunt resistor converted to 1~5V, input from 16+, 15-

Note 2:

Fixed with one channel alarm and communication
Main output can be selected among G, X3, L2, K1, K50, K60 or W1. Alarm is mandatorily defined as AU1.

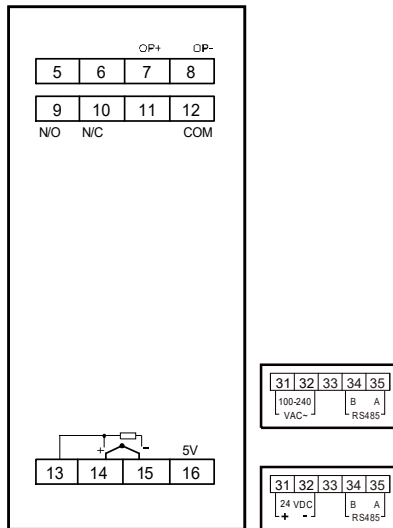

Wiring diagram of dimension E71 (22.5 x 100mm)

Note1: Input

0~5V/1~5V input from 16+, 15-

500mV below input from 14+, 15-

4~20mA with 250ohm shunt resistor converted to
1~5V, input from 16+, 15-

Note 2:

Fixed with one channel alarm and communication
Main output can be selected among G, X3, L2,
K1, K50, K60 or W1. Alarm is mandatorily defined
as AU1.

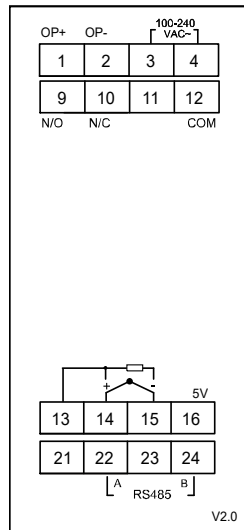

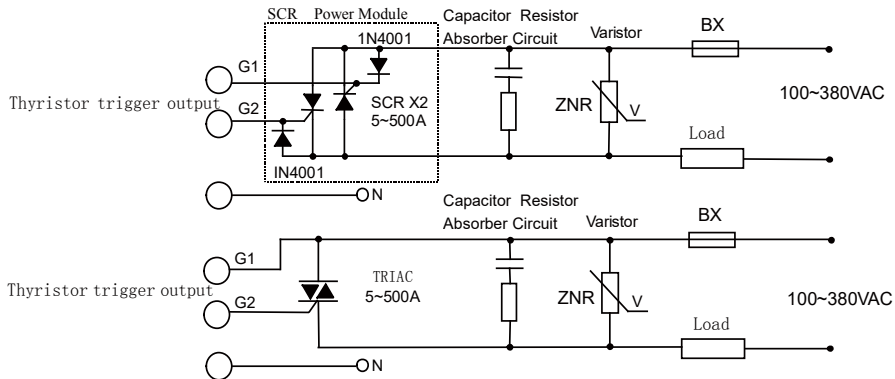

Note 1: According to the voltage and current of load, choose a suitable varistor to protect the thyristor.

A resistor-capacitor circuit (RC circuit) is needed for inductance load or phase-shift trigger output.

Note 2: SCR power module is recommended. A power module includes two SCRs, is similar to the above dashed square.

Note 3: When K60 module is used, the power should be 380VAC. When K50 phase-shifting triggering module is used, the AC power range is narrowed to 200~240VAC. The power frequency must be 50Hz. When K501 module is used, terminal 13 must be connected to neutral.

Note 4: When K50 and K60 are used, terminal 13 cannot be connected to N. If K501 is used, terminal 13 must be connected to N

2. DISPLAYS AND OPERATIONS

2.1 Front Panel Description

- ① Upper display window: Displays PV, parameter code, etc.
- ② Lower display window: Displays SV, parameter value, or alarm message
- ③ Setup key: For accessing parameter table and conforming parameter modification.
- ④ Data shift key (cursor pointer)
- ⑤ Data decrease key (RUN/HOLD button)
- ⑥ Data increase key (STOP button)
- ⑦ 10 LED indicators. MAN is not applicable in this series. PRG turns on when program is running. MIO, OP1, OP2, AL1, AL2, AU1 and AU2 turns on when the corresponding module are giving output. COMM turns on when the instrument is communicating with upper device.

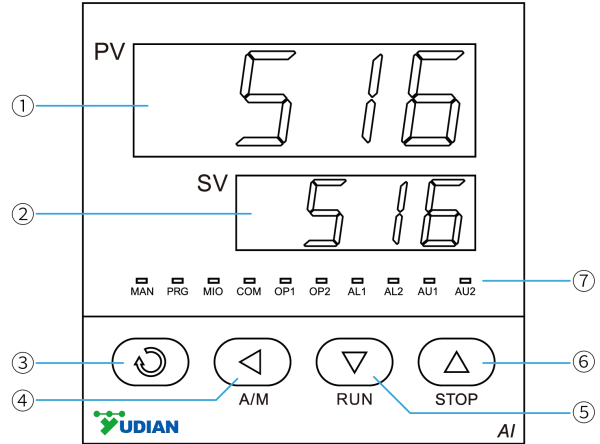

When power is on, the upper display shows the process value (PV) and the lower display shows the set point (SV). At certain circumstances, the lower display blinks SV and the following status message. The symbol message:

Symbol	Description
orAL	Input measurement value is out of range. The possible reasons are incorrect input specification, disconnected thermocouple or short circuited.
HIAL	High limit alarm
LoAL	Low limit alarm
HdAL	Deviation high alarm
LdAL	Deviation low alarm
StoP	Program is in stop status
Hold	Program is in hold status
rdy	Program is in ready status (Only available in AI-516P)

Note: The alarm message can be turned off by setting parameter AdIS to oFF.

2.2 D71/E71 Rail Mount Panel Description

- ① Upper display window, displays PV, parameter code, etc.
- ② Lower display window, displays SV, parameter value, or alarm code.
- ③ Setup key, for accessing parameter table and conforming parameter modification.
- ④ Data decrease key (RUN/HOLD button)
- ⑤ Data increase key (STOP button)
- ⑥ Data shift key (set point cursor)
- ⑦ Among five LED indicators O1, O2, O3 and O4 are matched with OP1, OP2, AU1 and AU2 respectively. C blinks when the instrument is communicating with upper device.

The basic display are the same as other panels which is explained in the previous section.

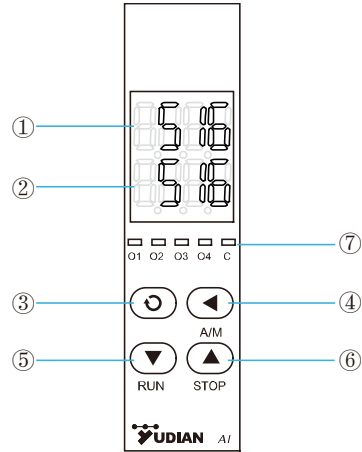



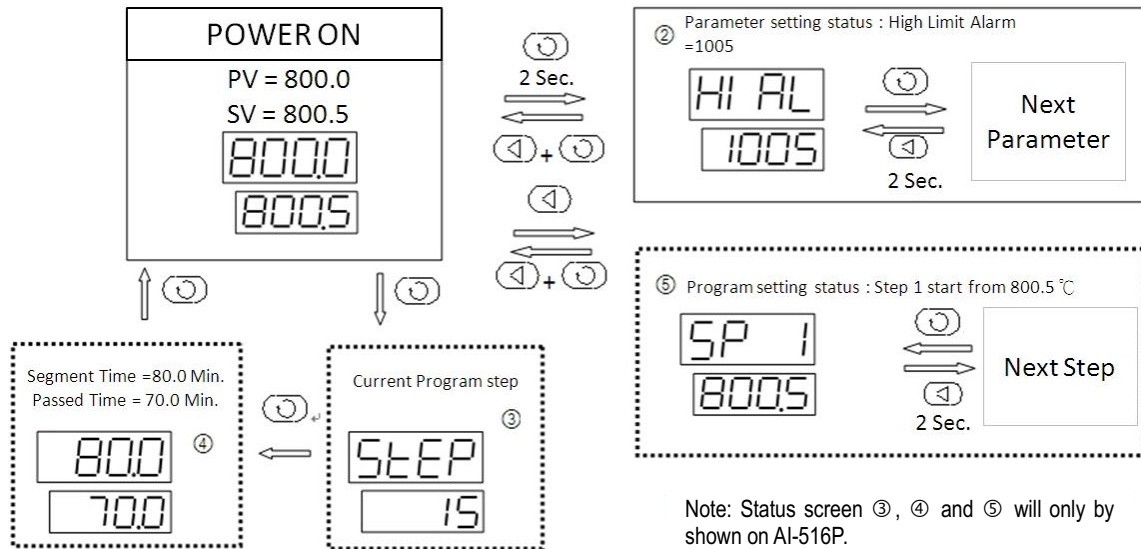







2.3 Display Status



2.4 Operation Description





2.4.1 Parameter Setting



In basic display status, press  and hold for about 2 seconds can access Field Parameter Table. Press  can go to the next parameter; press ,  or  can modify a parameter. Press and hold  can return to the previous parameter. Press  (don't release) and then press  key simultaneously can escape from the parameter table. The instrument will escape automatically from the parameter table if no key is pressed within 25 seconds, and the change of the last parameter will not be saved.

In Field Parameter Table,  till the last field parameter Loc appears. Setting Loc=808 and then press  can access System Parameter Table.

2.4.2 Short-cut operation

All function in AI-516/516P can be accessed through changing parameters. For common operation such as set point editing, changing the status of program RUN/STOP/HOLD, short-cut key is provided. These short-cut can be prohibited to avoid any incorrect operation.





Set point editing: Press  to start to edit set point. Then press ,  or  to adjust SV value.

Program segment setting (AI-516P only): Press  once to enter program setting status. The set point of the current program StEP will be displayed. Press  to go to the next parameter and value. Every StEP is based on the sequence in “setpoint1- time1-setpoint2- time2, etc”. Program StEP can modify anytime even the program

still in running.

RUN the program: Press and hold  key for about 2 seconds until the lower display window displays the "run" message. AI-516P will start the program from STOP status. If parameter "PAF.F =1" and program status is RUN, this operation will HOLD the program. The timer will be paused. Perform RUN operation again will resume the program.

STOP the program: Press and hold  key for about 2 seconds until the lower display window displays the "StOP" message. The instrument output will be stopped. AI-516P will stop the program and restore the current StEP number to 1.

Auto Tuning: Press  for 2 seconds, "At" parameter will appear. Press  to change the value of "At" from "oFF" to "on", then press  to activate the auto-tuning process. (If SP_r parameter is set to be effective and the instrument is at the limit of increasing rate, auto-tuning will be paused temporary.) During auto tuning, the lower display blinks with "At". After two fluctuating cycles by on-off control, the instrument will obtain the optimal PID control parameter value. If you want to quit from auto tuning, press and hold the  key for about 2 seconds until the "At" parameter appear again. Change "At" from "on" to "oFF", press  to confirm, then the auto tuning process will be cancelled. If the instrument is running the program, the program timer will be paused to avoid changing SV. If the controller was applied on heat/cooling dual output system, those two set of PID parameters are required to be calculated separately. When the controller was performing cooling control from AUX, enable auto tuning to obtain P2, I2, d2

- Note 1:** The advanced artificial intelligence algorithm APID is able to avoid overshooting problem over standard PID algorithm and achieve precise control. Both APID and PID can be calculated based on auto-tuning.
- Note 2:** Different set point will result in different PID values from auto-tuning. Please input the set point to an value which is often used or mean value. For those ovens with good heat preservation, the set point can be set at the highest applicable temperature. Depending on the system, the auto-tuning time may vary from seconds to hours.
- Note 3:** Parameter CHYS (on-off differential, control hysteresis) has influence on the accuracy of auto-tuning. In general, the smaller the value of CHYS, the higher precision of auto-tuning will be. There is a chance that the CHYS value is too small so as to work as on-off control. Then the resulting PID values will be completely misled. CHYS=2.0 is recommended.
- Note 4:** AI series instrument has the function of self-adaptation. It will learn and refine the configuration. The outcome from at the first run after auto-tuning may not be perfect but it will come to the best after a period of usage.

3. PARAMETERS AND SETTINGS

3.1 Parameter Lock (Loc) And Field Parameters

The parameters table can be customized. Those parameters required to be edited are grouped as “Field Parameter”. Field Parameter is a sub-table from the full parameter table. This sub-table can be defined by user. Access to full parameter table requires a password. Parameter lock (Loc) provides different operation privilege and access control to the parameter table. The explanation of Loc function was shown as below:

√ : Allowed to modify data or execute

X : Not allowed to modify data or execute

Loc	SV Set Point	At Auto-tune	Field Parameter	Full Parameter	Short-cut (Program RUN/HOLD/STOP)	Program Step Time & Temp.
0~1	√	√	√	X	√	√
2~3	√	X	√	X	√	X
4~255	X	X	X	X	X	X
808	√	√	√	√	√	√

Loc 808 is the master password, this valve can be change by parameter PASd. **Please set PASd cautiously, if the password lost, you can't access the parameter table again.**

There are 8 field parameters can be defined by as EP1~EP8. If the quantity of the field parameters is less than 8, the first idle EP parameter should be set to “nonE”. The initial values of EPs and Loc are EP1=HIAL, EP2=LoAL, EP3=HdAL, EP4=LdAL, EP5=nonE, EP6=nonE, EP7=nonE, EP8=nonE and Loc=0.

You can redefine field parameters and Loc to change operation style. For example, you can execute auto tuning from field parameter instead of by pressing  in basic display status, and only take HIAL and HdAL as field parameter.

The EP paramters and Loc should be set as follows: EP1=HIAL, EP2=HdAL, EP3=At, EP4=nonE

3.2 The Parameter Table

The parameters can be divided to 8 groups including alarm, control, input, output, communication, system, set point/program step and field parameter:

Code	Name	Description	Setting Range
HIAL	High limit alarm	Alarm turns on when $PV > HIAL$ Alarm turns off when $PV < HIAL - AHYS$, Set to the maximum value to disable the alarm. Alarm output location can be defined by parameter AOP. All alarms can be assigned to AL1, AL2, AU1, AU2 or none. More alarm allocation is explained in AOP section below.	-9990~ +32000 units
LoAL	Low limit alarm	Alarm turns on when $PV < LoAL$ Alarm turns off when $PV > LoAL + AHYS$ Set to the minimum value to disable the alarm. HIAL and LoAL can be assigned as deviation alarms. Details please refer to the description of parameter AF.	
HdAL	Deviation high alarm	Alarm turns on when $PV - SV > HdAL$; Alarm turns off when $PV - SV < HdAL - AHYS$ Set to the maximum value to disable the alarm.	
LdAL	Deviation low alarm	Alarm turns on when $PV - SV < LdAL$ Alarm turns off when $PV - SV > LdAL + AHYS$ Set to the minimum value to disable the alarm. HdAL and LdAL can be assigned as absolute high limit and low limit alarms. Details please refer to the description of parameter AF.	
AHYS	Alarm hysteresis	Also known as dead band or lag. To avoid frequent alarm on-off action caused by the fluctuation of PV. Usage of AHYS is shown above.	0~2000 units

AdIS	Alarm display	oFF : No alarm message shown in the lower display even there is an alarm on : Alternately showing alarm message and value in the lower display when there is an alarm	oFF / on																														
AOP	Alarm output allocation	<table border="1" data-bbox="425 264 1484 507"> <thead> <tr> <th>Alarm Output to</th> <th>LdAL (x 1000)</th> <th>HdAL (x100)</th> <th>LoAL (x10)</th> <th>HIAL (x1)</th> </tr> </thead> <tbody> <tr> <td>None</td> <td>0</td> <td>0</td> <td>0</td> <td>0</td> </tr> <tr> <td>AL1</td> <td>1</td> <td>1</td> <td>1</td> <td>1</td> </tr> <tr> <td>AL2</td> <td>2</td> <td>2</td> <td>2</td> <td>2</td> </tr> <tr> <td>AU1</td> <td>3</td> <td>3</td> <td>3</td> <td>3</td> </tr> <tr> <td>AU2</td> <td>4</td> <td>4</td> <td>4</td> <td>4</td> </tr> </tbody> </table> <p data-bbox="624 512 763 543">Example:</p> <p data-bbox="624 543 1310 606">AOP = $\frac{3}{\text{LdAL}}$ $\frac{3}{\text{HdAL}}$ $\frac{0}{\text{LoAL}}$ $\frac{1}{\text{HIAL}}$</p> <p data-bbox="425 606 1484 668">It shows that HdAL and LdAL are sent to AU1, LoAL has no output, HIAL is sent to AL1.</p> <p data-bbox="425 668 1484 735">Note 1: When AUX is used as auxiliary output in bidirectional (heating/refrigerating) control, alarms assigned to AU1 and AU2 does not take in effect.</p> <p data-bbox="425 735 1484 797">Note 2: Installing L3 dual relay output module in ALM or AUX, AL2 or AU2 can be used.</p>	Alarm Output to	LdAL (x 1000)	HdAL (x100)	LoAL (x10)	HIAL (x1)	None	0	0	0	0	AL1	1	1	1	1	AL2	2	2	2	2	AU1	3	3	3	3	AU2	4	4	4	4	0~4444
Alarm Output to	LdAL (x 1000)	HdAL (x100)	LoAL (x10)	HIAL (x1)																													
None	0	0	0	0																													
AL1	1	1	1	1																													
AL2	2	2	2	2																													
AU1	3	3	3	3																													
AU2	4	4	4	4																													
Ctrl	Control mode	onoF: on-off control, for situation not requiring high precision APId: advanced artificial intelligence PID control. (Recommended) nPid: standard PID algorithm with anti integral-saturation function (no integral when	onoF APId nPid																														

		<p>PV-SV > proportional band) POP: Direct PV retransmission, working as a temperature re-transmitter. SOP: Direct SV retransmission, working as a program generator (AI-516P).</p>	POP SOP
Srun	Running Status	<p>run: Control or program is in effect. "PRG" indicator lights up. StoP: Control or program is stopped. Lower display keeps flashing "StoP". "PRG" indicator goes off. HoLd: Control or program is paused. If the controller is a constant temperature controller without time limit, (AI-516 or AI-516P with parameter Pno=0), this HoLd status is equal to normal status but panel shortcut to RUN or STOP operation is prohibited. in this status, for the controller works as program control (Pno>0), the output keeps going but the program timer is paused. At the same time, lower display flashes "HoLd" and PRG blinks. Panel shortcut to RUN or STOP is allowed to change this status. Remark: Using panel shortcut key is unable to activate HoLd status but only through changing Srun parameter or programmed in the program steps.</p>	StoP / run / HoLd
Act	Acting method	<p>rE: Reverse acting. Increase in measured variable causes a decrease in the output, such as heating control. dr: Direct acting. Increase in measured variable causes an increase in the output, such as refrigerating control. rEbA: Reverse acting with low limit alarm and deviation low alarm blocking at the beginning of power on. drbA: Direct acting with high limit alarm and deviation high alarm blocking at the beginning of power on.</p>	rE dr rEbA drbA

At	Auto tuning	oFF: Auto tuning function was off. on: Active auto turning function to calculate the values FoFF : Auto tuning function was off, cannot activate again by pressing key from panel .	oFF / On / FoFF
P	Proportional band	Proportional band in PID and APID control. Instead of percentage of the measurement range, the unit is the same as PV. Generally, optimal P, I, D and Ctl can be obtained by auto tuning. Those values can be manually entered if they are known already.	1~32000 units
I	Time of Integral	No integral effect when I=0	0~9999 seconds
d	Time of Derivative	No derivative effect when d=0	0~999.9 seconds

Ctl	Control period	<p>Small value can improve control accuracy. For SSR, thyristor or linear current output, it is generally 0.5~3 sec. For Relay output or in a heating/refrigerating dual output control system, generally 15~40 sec, because small value will cause the frequent on-off action of mechanical switch or frequent heating/refrigerating switch, and shorten its service life. Ctl is recommended to be 1/5 – 1/10 of derivative time. (It should be integer times of 0.5 second.) When the parameter OPt or Aut = rELy, Ctl will be limited to more than 3 seconds. Auto tuning will automatically set Ctl to suitable value considering both control precision and mechanical switch longevity. When the parameter Ctrl = onoF, Ctl will used as timer to make delay time to avoid the power restart in short period. It suit for compressor protection.</p>				0.2~300.0 Sec
CHYS	Control Hysteresis	<p>CHYS is used for on-off control to avoid frequent on-off action of relay. For a reverse acting (heating) system, when PV > SV, output turns off; when PV<SV-CHYS, output turns on. For a direct acting (cooling) system, when PV<SV, output turns off; when PV>SV+CHYS, output turns on.</p>				0~2000
InP	Input specification Code	InP	Input spec.	InP	Input spec.	0~106
		0	K	21	Pt100	
		1	S	22	Pt100 (-80~+300.00℃)	
		2	R	25	0~75mV voltage input	
		3	T	26	0~80ohm resistor input	
		4	E	27	0~400ohm resistor input	

		<table border="1"> <tbody> <tr> <td>5</td> <td>J</td> <td>28</td> <td>0~20mV voltage input</td> </tr> <tr> <td>6</td> <td>B</td> <td>29</td> <td>0~100mV voltage input</td> </tr> <tr> <td>7</td> <td>N</td> <td>30</td> <td>0~60mV voltage input</td> </tr> <tr> <td>8</td> <td>WRe3-WRe25</td> <td>31</td> <td>0~1V voltage input</td> </tr> <tr> <td>9</td> <td>WRe3-Wre26</td> <td>32</td> <td>0.2~1V voltage input</td> </tr> <tr> <td>10</td> <td>Extended input specification *</td> <td>33</td> <td>1~5V voltage input</td> </tr> <tr> <td>12</td> <td>F2 radiation type pyromter</td> <td>34</td> <td>0~5V voltage input</td> </tr> <tr> <td>15</td> <td>4~20mA (installed I4 module in MIO)</td> <td>35</td> <td>-20~+20mV</td> </tr> <tr> <td>16</td> <td>0~20mA (installed I4 module in MIO)</td> <td>36</td> <td>-100~+100mV</td> </tr> <tr> <td>17</td> <td>K (0~300.00℃)</td> <td>37</td> <td>-5~+5V</td> </tr> <tr> <td>18</td> <td>J (0~300.00℃)</td> <td>39</td> <td>20~100mV</td> </tr> <tr> <td>19</td> <td>Ni120</td> <td></td> <td></td> </tr> <tr> <td>20</td> <td>Cu50</td> <td></td> <td></td> </tr> </tbody> </table> <ul style="list-style-type: none"> ● While InP=10, the non-linear table can be self-defined or input by factory under a paid service. 	5	J	28	0~20mV voltage input	6	B	29	0~100mV voltage input	7	N	30	0~60mV voltage input	8	WRe3-WRe25	31	0~1V voltage input	9	WRe3-Wre26	32	0.2~1V voltage input	10	Extended input specification *	33	1~5V voltage input	12	F2 radiation type pyromter	34	0~5V voltage input	15	4~20mA (installed I4 module in MIO)	35	-20~+20mV	16	0~20mA (installed I4 module in MIO)	36	-100~+100mV	17	K (0~300.00℃)	37	-5~+5V	18	J (0~300.00℃)	39	20~100mV	19	Ni120			20	Cu50			
5	J	28	0~20mV voltage input																																																				
6	B	29	0~100mV voltage input																																																				
7	N	30	0~60mV voltage input																																																				
8	WRe3-WRe25	31	0~1V voltage input																																																				
9	WRe3-Wre26	32	0.2~1V voltage input																																																				
10	Extended input specification *	33	1~5V voltage input																																																				
12	F2 radiation type pyromter	34	0~5V voltage input																																																				
15	4~20mA (installed I4 module in MIO)	35	-20~+20mV																																																				
16	0~20mA (installed I4 module in MIO)	36	-100~+100mV																																																				
17	K (0~300.00℃)	37	-5~+5V																																																				
18	J (0~300.00℃)	39	20~100mV																																																				
19	Ni120																																																						
20	Cu50																																																						
		<ul style="list-style-type: none"> ● 																																																					
dPt	Display Resolution	<p>Four formats (0, 0.0, 0.00, 0.000) are selectable</p> <p>Note 1: For thermocouples or RTD input, only 0 or 0.0 is selectable, and the internal resolution is 0.1. When S type thermocouple is used, dPt is recommended to be 0. If Inp= 17,18 or 22, resolution will support display 0.0 or 0.00</p>	<p>0 / 0.0 / 0.00 / 0.000</p>																																																				

SCL	Signal scale low limit	Define scale low limit of input. It is also the low limit of transmitter output (Ctrl=POP or SOP) and light bar display.	-9990~ +32000 units
SCH	Signal scale high limit	Define scale high limit of input. It is also the high limit of retransmission output (Ctrl=POP or SOP) and light bar display.	
Scb	Input Shift Adjustment	Scb is used to shift input to compensate the error caused by transducer, input signal, or auto cold junction compensation of thermocouple. PV after compensation=PV before compensation + Scb It is generally set to 0. The incorrect setting will cause measurement inaccurate.	-1999~ +4000 units
FILt	PV input filter	The value of FILt will determine the ability of filtering noise. When a large value is set, the measurement input is stabilized but the response speed is slow. If high interference exists, you can increase parameter "FILt" gradually to make momentary fluctuation of measured value less than 2 to 5 digits. When the instrument is being metrological verified, FILt can be set as 0 or 1 to shorten the response time. The unit of FILt is 0.5 second.	0~40
Fru	Selection of power frequency and temperature scale	50C: Power at 50Hz and maximum anti-interference is achieved ; Display in °C 50F: Power at 50Hz and maximum anti-interference is achieved; Display in °F 60C: Power at 60Hz and maximum anti-interference is achieved; Display in °C 60F: Power at 60Hz and maximum anti-interference is achieved, Display in °F.	50C, 50F, 60C, 60F

OPt	Main output type	<p>SSr: Output SSr drive voltage or thyristor zero crossing trigger signal. G, K1 or K3 module should be installed. The output power can be adjusted by the on-off time proportion. The period (Ctl) is generally 0.5~4 seconds.</p> <p>rELy: for relay contact output or for execution system with mechanical contact switch. To protect the mechanical switch, the output period (Ctl) is limited to 3~120 seconds, and generally is 1/5 to 1/10 of derivative time.</p> <p>0-20: 0~20mA linear current output. X3 or X5 module should be installed in OUTP slot.</p> <p>4-20: 4~20mA linear current output. X3 or X5 module should be installed in OUTP slot. (Not applicable for heating/refrigerating bidirectional control.)</p> <p>PHA: Single-phase phase-shift output. K50 module should be installed in OUTP slot.</p>	<p>SSr</p> <p>rELy</p> <p>0-20</p> <p>4-20</p> <p>PHA</p>
OPL	Output low limit	0~100%: OPL is the minimum output of OUTP in single directional control system.	0~110%
OPH	Output upper limit	OPL limits the maximum of OUTP (main output) when PV<OEF. OPH should be greater than OPL.	0~110%
OEF	Work range of OPH	<p>When PV<OEF, the upper limit of OUTP is OPH; when PV>OEF, the upper limit of OUTP is 100%.</p> <p>For example, to avoid that the temperature raises too quickly, under 150℃, a heater can work only under 30% of power, then we can set OEF=150.0 (℃), OPH=30 (%)</p>	-999~ +3200
Addr	Communication address	In the same communication line, different instrument should be set to different address.	0~100
bAud	Baud rate /	The bAud parameter defines the communication baud rate, and the definable range is	0~28.2K

	COMM mode selection	<p>0~28800bit/s (28.8K). When the COM position is not used for the communication function, the bAud parameter can be set to use the COM port as other functions:</p> <p>bAud=1, as an external switch input, the function is the same as the MIO position, when the MIO position is occupied, the I2 module can be installed in the COMM position.</p> <p>bAud=3, use the COMM port as the 0~20mA measurement value transmission output function;</p> <p>bAud=4, use the COMM port as the 4~20mA measurement value transmission output function;</p> <p>bAud=8, use the COMM port as a 0~20mA given value to transmit the output function;</p> <p>bAud=12, use COMM port as 4~20mA given value transmission output function</p>	
Et	Event Input Type (AI-516P only)	<p>nonE: Disable event input function</p> <p>ruSt: RUN/STOP switch. Connect MIO in a short time to RUN the program. Connect MIO and hold for more than 2s to STOP the program.</p> <p>SP1.2: In fixed-point control (AI-516P parameter Pno=0), set value SV=SP1 when MIO is open. SV=SP2 when MIO is closed.</p> <p>Erun: RUN/STOP switch. Connect MIO to RUN the program. Disconnect MIO to STOP the program.</p>	nonE / ruSt / SP1.2 / Erun
AF	Advanced function	<p>AF is used to select advanced function. The value of AF is calculated as below: $AF = Ax1 + Bx2 + Cx4 + Dx8 + Ex16 + Fx32 + Gx64 + Hx128$ A=0: HdAL and LdAL work as deviation high and low limit alarms; A=1: HdAL and LdAL work as high and low limit alarms, and the instrument can have two groups of high and low limit alarms. B=0: Alarm and control hysteresis work as unilateral hysteresis; B=1: As bilateral hysteresis.</p>	0~255

		<p>C=0: The light bar indicates the output value; C=1: The light bar indicates the process value (for instruments with light bar only). D=0: Reserved. E=0: Normal application on HIAL and LoAL; E=1: HIAL AND LoAL will become to deviation high alarm and Deviation low alarm F=0: Fine control mode, internal control resolution was demonstration's 10 times. When on linear input mode, biggest display value is 3200 units F=1: Wide range display mode, when the value is bigger than 3200 ,chooses this option. G=0, When the thermocouple or RTD input is burnt out, PV value will increase and trigger the high limit alarm. (Available for certain version of firmware) G=1, When the thermocouple or RTD input is burnt out, PV value will increase and NOT trigger the high limit alarm. After it was sets, High Limit alarm will have 30 sec. delay for trigger in normal usage. Note: AF=0 is recommended for ordinary usage.</p>	
AFC	Communication mode	<p>AFC parameter use to choose communication mode: $AFC=A*1+D*8$ A=0: Communication protocol: MODBUS A=1: Communication protocol: AIBUS A=2: Communication protocol: Old MODBUS Compatibility Mode D=0: No parity; D=1: Even parity.</p>	
PASd	Password (AI-516 only)	<p>When PASd=0~255 or AF.D=0, set Loc=808 can enter the full parameter table. When PASd=256~9999 and AF.D=1, only Loc=PASd can access the full parameter table. Please setting PASd cautiously, if the password is lost you cannot access the parameter table again.</p>	

SPL	Low limit of SV	Minimum value that SV is allowed to be.	-999~ +3000 unit
SPH	Upper limit of SV	Maximum value that SV is allowed to be.	
SPr	Ramp Slope limit (Only for AI-516P)	Provided that SPr is set, the program start with the first step of ramp slope limited by SPr value until the temperature reach the first SV, if PV<SV. PRG indicator blinks. For Ramp mode, SPr had effect on first step only. For Soak mode, SPr had effect on each step.	0~3200°C / minute
Pno	No. of Program step (Only for AI-516P)	To define the quantity of program step to be used and hide the unnecessary ones for ease of configuration and operation. Pno= 0 , disable the program running mode, then AI-516P will same as AI-516, meanwhile, can set the parameter “SPr” to limit the ramp time. Pno=1~30 , AI-516P working as normal programmable controller	0~30
PonP	Program run mode after power restart	Cont : Continue to run the program from the original break point. If STOP status is activated before power cut, then the program will keep at STOP status after power restarts. StoP : Stop the program after power restart run1 : Start to run the program from step 1 unless the instrument was in “STOP” status before power cut. dASt (AI-516P only) : Continue to run the program from the original break point. If there are any deviation alarm, it will stop the program HoLd (AI-516P only) : No matter any circumstances, the instrument enters HoLd status after power resumes. If it is in StoP status before power cut, it will keep in StoP status after power resumes.	Cont / StoP / run1 / dASt / HoLd

EP1~ EP8	Field parameter definition	Define 1~8 field parameters for those common used parameters when the Loc lock is applied. If there is none or less than 8 field parameters, please set as nonE.	nonE and all parameter codes
---------------------	----------------------------------	--	---------------------------------------

3.3 Additional Explanation On Special Functions

3.3.1 Single-phase phase-shift trigger output

When OPT is set to PHA, installing a K50 or K60 module in OOTP slot can single-phase phase-shift trigger a TRIAC or 2 inverse parallel SCRs. It can continuously adjust heating power by control the conduction angle of thyristor. With non-linear power adjustment according to the characters of sine wave, it can get ideal control. The trigger adopts self-synchronizing technology, so it can also work even when the power supplies of the instrument and the heater are different. Phase-shift trigger has high interference to the electric power, so user should pay attention to the anti-interference ability of other machines in the system. Now the K50 or K60 module can be only used in 50Hz power grid.

3.3.2 Alarm blocking at the beginning of power on

Sometimes the fault alarm may occur at the beginning of power on. In a heating system, at the beginning of power on, its temperature is much lower than the set point. If low limit and deviation low limit are set and the alarm conditions are satisfied, the instrument should alarm, but there is no problem in the system. Contrarily, in an refrigerating system, the unnecessary high limit or deviation high limit alarm may occur at the beginning of power on. Therefore, AI instruments

offer the function of alarm blocking at the beginning of power on. When Act is set to rEbA or drbA, the corresponding low or high alarms are blocked until the alarm condition first clears. If the alarm condition is satisfied again, the alarm will work.

3.3.3 Communication function

S or S4 module can be installed at COMM slot to communicate with a computer. The instrument can be controlled by computer. AI instruments can be connected to the computer through RS232C/RS485 convertor or USB/RS485 convertor. Every communication port of a computer can connect up to 60 AI instruments. With RS485 repeater, up to 80 AI instruments can be connected. If large quantity of instrument is required, 2 or above computers can be used with a local network formed. Please note that every instrument connecting to the same communication line should be set to a unique communication address.

AIDCS application software, a distributed control system software developed by Yudian, can control and manage 1~200 AI instruments, record the data, generate and print reports. If users want to develop their own distributed control system by themselves, the communication protocol of AI instruments can be free offered. There are many famous distributed control system software support AI instruments.

3.3.4 Temperature re-transmitter / Program generator

Apart from AI PID/PID control and on-off control, the instrument can retransmit PV (processed value) or SV (set value) from OUTP terminals. When the output is defined as current output, AI-516 becomes a temperature re-transmitter while

AI-516P becomes a program generator. The precision of 4~20mA current output is 0.3%FS.

The corresponding parameters are set as below:

When Ctrl=PoP, PV is retransmitted. When Ctrl=SOP, SV is transmitted.

Parameter OPt defines the specification of output, generally it is 4~20mA or 0~20mA.

Parameter InP, SCH, SCL and Scb define the input specification, setting low limit or high limit of PV and doing adjustment.

For example, in order to retransmit temperature reading from a K-type thermocouple, ranging 0~400℃, output as current 4~20mA, the parameters are set as below: InP=0, ScL=0.0, ScH=400.0, OPt=4-20. X3 or X5 linear current module is installed in OUTP slot. When the temperature is lower than or equal to 0℃, the output is 4mA. When the temperature equals to 400℃, the output is 20mA. When the temperature reading is in between 0~400℃, the output will sit between 4~20mA.

4. Program Control (AI-516P Only)

AI-516P program temperature controller is used in the application where the set point to be changed automatically with the time. It provides 30 segments program control which can be set in any slope and the function of jump, run, hold and stop can also be set in the program. Measurement startup function, preparation function and power-cut/power-resume event handling modes also provided.

4.1 Functions And Concepts

Program Step:

The number of the program Step can be defined from 1 to 30. The current Step is the program Step being executing.

Program time:

Total run time of the program step. The unit is minute or hour. The value range is from 0.1 to 3200.

Running time:

The Time of current Step has run. As the running time reaches the Step time, the program will jump to the next Step automatically.

Jump:

The program can jump to any other steps in the range of 1 to 30 automatically as you programmed in the program Step, and realize cycle control.

Run (run):

When program is in the running status, timer counts. SV (Set value) changes according to the preset curve. When program is in the holding status (Paused HoLd), timer paused. SV (set value) remains to hold at that temperature. The holding operation can only be programmed into the program steps but not from panel.

Stop (StoP):

When the stop operation is activated, the program will stop, running time will be clear, event output switch will reset and the output control will stop output. If run operation is activated when instrument is in the stop status, the program will start-up and run again from the assigned step number. The stop function can be programmed into the program steps. The stop operation can also be performed manually at any time. (After stop operation is done, the step number will be set to 1, but user can modify it again). If the program has already reached the last step defined in Pno, the program will stop automatically.

Power cut/resume event handling:

There are 5 events handling method selectable for power resume after power cut off. Please refer to parameter PonP.

PV preparation function (rdy function) :

When the program is running and it is required to resume after accidental power restart, and if the PV (process value) is different with SV (set value) (If PV Startup feature is enabled, the system will use PV Startup in priority. If PV Startup effect is significant, PV Preparation/Ready function is not required. In circumstances which does not fit the criteria of PV Startup we will use PV Preparation/Ready function), as well as the difference is larger than deviation alarm (HdAL and LdAL), instrument will not immediately activate deviation alarm. Instead it will try to adjust the PV in order the deviation will be minimized to lower than the value of deviation alarm. The program timer will be paused. The deviation alarm(s) will be suppressed. Until the positive and negative deviation meet the requirement, the instrument will start the to run the program. This PV Preparation/Ready function is effective for those step(s) with unpredictable time required for increasing/decreasing temperature. Activation and deactivation of this function can be changed in PAF parameter. PV Preparation/Ready function ensures the integrity of the program curve. On the other hand, the extra preparation time may prolong the whole program time. Both PV Preparation/Ready function and PV Startup feature deal with the uncertainty of indifference between PV and SV during program running. Hence an efficient and complete program profile can be achieved.

PV Startup

When the program is running and it is required to resume after accidental power restart, the PV (process value) is often different from SV (set value). This scenario is unavoidable but also undesirable. For example, the program is set to raise the temperature from 25°C to 625°C in 600 minutes, at a rate of 1°C per 1 minute. Assume when the program starts, PV is 25°C, the program profile runs smoothly. But if the PV is higher than 25°C, the program cannot be run as expected. PV Startup feature can ask the instrument to adjust the running time to fit in. If the current PV is 100°C, the instrument will automatically to run this program at the moment of 75 minutes, that mean changed the temperature raised from 100°C to 625°C in 525 minutes (600-75) min.

Curve fitting:

Curve fitting is adopted as a kind of control technology for AI-516P series instrument. As controlled process often has lag time in system response, by the way of curve fitting the instrument will smooth the turning point of the linear heating-up, cooling-down and constant temperature curves automatically. The degree of the smooth is relevant with the system's lag time t ($t=d+CtI$) ; the longer of the lag time, the curve will more smooth. On the opposite the smooth function will be weaker. Generally the shorter of the process lag time (such as temperature inertia), the better of the program control on effect. By the way of the curve fitting to deal with the program curves, will avoid overshoot. Note: The characteristic of the curve fitting will force the program control to generate fixed negative deviation during the linear heating-up and fixed positive deviation during the linear cooling-down, the deviation is direct proportional to the lag time and the speed of heating-up (cooling-down). This phenomenon is normal.

4.2 Program Arrangement

4.2.1 Ramp Mode

When the parameter PAF.B=0, the program arrangement is set in the format of temperature-time-temperature, which means temperature "A"(SP 1), passed Time "A"(t01), then reached Temperature "B"(SP 2). The unit of temperature is the same as PV (processed value). The unit of time can be minute or hour (By default it is minute). In ramp mode, when the program pointer reaches the last step number defined in Pno parameter, the instrument will hold the time (t) at the temperature (SPx) then ends the program, unless the SPx value is a command for stop or jump.

The following example includes 5 steps, which is linear temperature heating up, constant temperature, linear

temperature cooling down, jump cycling, ready, Hold..

Step 1: SP 1=100 , t 1=30.0 Start linear temperature heating up from 100°C . Time required is 30 minutes. Rate of temperature increase is 10°C/minute.

Step 2: SP 2=400 , t 2=60.0 Temperature 400°C is kept for 60 minutes.

Step 3: SP 3=400 , t 3=120.0 Temperature cooling at a rate of cooling is 2°C/minute. Time needed is 120 minutes to reach SP4

Step 4: SP 4=160 , t 4=0.0 When temperature reached 160 degree, the program paused (HoLd status). User has to execute "run" to proceed to next steps.

Step 5: SP 5=160 , t 5=-1.0 Jump to Step 1 to start from beginning in a loop.

In the example above, When the program jump from step 5 to step 1, the temperature is 160°C which is not equal to the value of step 1 as 100°C . The step 5 is a command step as well. Assuming that the deviation high alarm is set to 5 °C , before the program jumping from step 4 to step 1, it will activate PV Preparation/Ready feature (if PV Preparation/Ready "rdy" was enabled) to regulate the temperature until the deviation between PV and SV is less than deviation high alarm value, i.e. 105°C . Then the program will be started from Step 1 again. The temperature control curve is illustrated below.

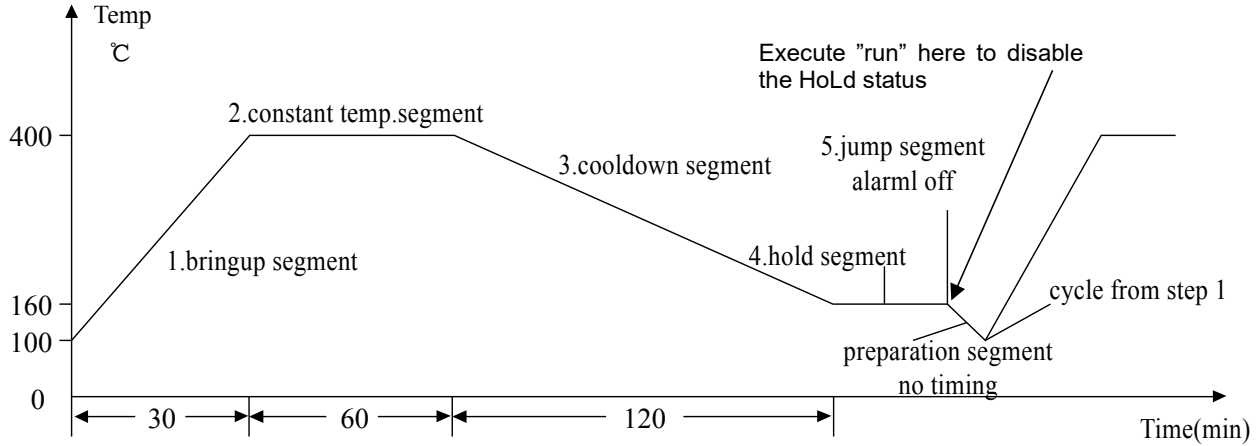

The advantage of applying “temperature-time-temperature” arrangement is to provide a wide window of setting rate of increasing and decreasing temperature. The format of increasing and decreasing temperature steps keep the same format, for ease to learn. There is a high flexibility to set the curve, enabling possibility to input continuous increasing curves (e.g. using different rate of increasing curve to achieve functional heating) or continuous temperature holding steps

4.2.2 Soak Mode

When the parameter PAF.B=1, soak mode is selected. This is suitable for the process which does not need to establish the temperature slope, simplifying the programming and using the quantity of steps more effectively. Each step contain the meaning of “temperature ~ holding time at that temperature”. Parameter “SPr” defines the rate of temperature change among steps. If “SPr=0”, the rate will set to maximum. Since the time of temperature increasing and it occupies the holding time, PV preparation/Ready feature “rdy” is advised to be used to ensure to obtain the correct soak time (holding time).

4.2.3 Time Setting

Set “t-xx” = 0.1 ~ 3200 (min)

Set the time of Step xx. (Time unit can be change to hour by parameter “PAF”.)

Set “t-xx” = 0.0

The program pauses (HoLd) on Step xx. The program will be paused and timer pauses counting.

Set “t-xx” = -121.0

The program stops(StoP), and go into stop status.

Set “t-xx” = -0.1 ~ -122.0

Negative value in time value represents a command (a jump operation + event output). The integral part “-1~-120” refers to the step number to jumped to. Step number greater than Pno (Number of program step) with non-zero decimal space does nothing but proceed to next step. Decimal place refers to programming of event output at AL1 and AL2. -XXX.0 indicates the event is none but step jumping only. Please note that if parameter AOP assigns alarm action at AL1 or AL2, no matter event outputs or ordinary alarms will cause alarms from AL1 and AL2.

The definition of -XXX.1 ~ -XXX.4 are as below

-XXX.1, AL1 activated, AL2 released

-XXX.2, AL1 released, AL2 activated

- XXX.3, AL1 activated, AL2 activated
- XXX.4, AL1 released, AL2 release

Example 1: $t-5 = -1.1$ When the program pointer arrives step 5, AL1 is activated. AL2 is released. The program jumps to step 1 to keep running.

Example 2: $t-6 = -0.3$ When the program arrives step 6, AL1 and AL2 are activated. The program proceeds to the next step (Step 7).

Note: Only when the “run” operation is executed or jumping during the power is just on, the program will continues to jump. If the program jump to a step setting itself is a jump step as well, the program will be paused (HoLd status. The system will automatically insert HoLd between two jump step). External run/Hold operation is needed to release this HoLd status. Please be reminded if the jumping destination is the step number itself(i.e. $t-6 = -6$), the HoLd status is not able to be released. This is a meaningless step.

4.2.4 Set Point Setting

The range of Set Point can be bounded by SPL and SPH which is $+999 \sim +3200^{\circ}\text{C}$. It represents the temperature to be controlled ($^{\circ}\text{C}$) or a linear unit.

4.2.5 Program arrangement of multi-curve operation

AI-516P has the advanced function of flexible program arrangement. Normally, when the program stops (StoP), the StEP will be automatically set to 1. If multiple curves are defined in all the steps available, the control method can be done by setting different jump steps in step 1, as a starting point.

For example: There are three curves with the length of 3 steps represent three groups of process parameter. They are separately arranged on Step 2~Step 4, Step 5 ~ Step 7 and Step 8 ~ Step 10.

By changing the step number:

t- 1=-2.0 Execute the program of curve 1 (Step 2 ~ Step 4)

t- 1=-5.0 Execute the program of curve 2 (Step 5 ~ Step 7)

t- 1=-8.0 Execute the program of curve 3 (Step 8 ~ Step 10)

When the manufacturing methodology is required to be changed, the curves can be loaded by setting the “t-1” as -2.0, -5.0 or -8.0. This jump selection step can also be omitted. The corresponding step number can be chosen before the program starts (run).